

# **RANGING DEMO (PC) USER GUIDE**

**Understanding and using the  
DecaRanging ranging demo (PC)  
application**

**Version 2.8**

**This document is subject to change without notice**

**DOCUMENT INFORMATION**

**Disclaimer**

Decawave reserves the right to change product specifications without notice. As far as possible changes to functionality and specifications will be issued in product specific errata sheets or in new versions of this document. Customers are advised to check the Decawave website for the most recent updates on this product

Copyright © 2016 Decawave Ltd

**LIFE SUPPORT POLICY**

Decawave products are not authorized for use in safety-critical applications (such as life support) where a failure of the Decawave product would reasonably be expected to cause severe personal injury or death. Decawave customers using or selling Decawave products in such a manner do so entirely at their own risk and agree to fully indemnify Decawave and its representatives against any damages arising out of the use of Decawave products in such safety-critical applications.



**Caution!** ESD sensitive device.  
Precaution should be used when handling the device in order to prevent permanent damage

**REGULATORY APPROVALS**

The DWM1000, as supplied from Decawave, has not been certified for use in any particular geographic region by the appropriate regulatory body governing radio emissions in that region although it is capable of such certification depending on the region and the manner in which it is used.

All products developed by the user incorporating the DWM1000 must be approved by the relevant authority governing radio emissions in any given jurisdiction prior to the marketing or sale of such products in that jurisdiction and user bears all responsibility for obtaining such approval as needed from the appropriate authorities.

## DISCLAIMER

This Disclaimer applies to the DW1000 API source code and the “DecaRanging” sample application source code (collectively “Decawave Software”) provided by Decawave Ltd. (“Decawave”).

Downloading, accepting delivery of or using the Decawave Software indicates your agreement to the terms of this Disclaimer. If you do not agree with the terms of this Disclaimer do not download, accept delivery of or use the Decawave Software.

Decawave Software is solely intended to assist you in developing systems that incorporate Decawave semiconductor products. You understand and agree that you remain responsible for using your independent analysis, evaluation and judgment in designing your systems and products. THE DECISION TO USE DECAWAVE SOFTWARE IN WHOLE OR IN PART IN YOUR SYSTEMS AND PRODUCTS RESTS ENTIRELY WITH YOU.

DECAWAVE SOFTWARE IS PROVIDED "AS IS". DECAWAVE MAKES NO WARRANTIES OR REPRESENTATIONS WITH REGARD TO THE DECAWAVE SOFTWARE OR USE OF THE DECAWAVE SOFTWARE, EXPRESS, IMPLIED OR STATUTORY, INCLUDING ACCURACY OR COMPLETENESS. DECAWAVE DISCLAIMS ANY WARRANTY OF TITLE AND ANY IMPLIED WARRANTIES OF MERCHANTABILITY, FITNESS FOR A PARTICULAR PURPOSE AND NON-INFRINGEMENT OF ANY THIRD PARTY INTELLECTUAL PROPERTY RIGHTS WITH REGARD TO DECAWAVE SOFTWARE OR THE USE THEREOF.

DECAWAVE SHALL NOT BE LIABLE FOR AND SHALL NOT DEFEND OR INDEMNIFY YOU AGAINST ANY THIRD PARTY INFRINGEMENT CLAIM THAT RELATES TO OR IS BASED ON THE DECAWAVE SOFTWARE OR THE USE OF THE DECAWAVE SOFTWARE WITH DECAWAVE SEMICONDUCTOR TECHNOLOGY. IN NO EVENT SHALL DECAWAVE BE LIABLE FOR ANY ACTUAL, SPECIAL, INCIDENTAL, CONSEQUENTIAL OR INDIRECT DAMAGES, HOWEVER CAUSED, INCLUDING WITHOUT LIMITATION TO THE GENERALITY OF THE FOREGOING, LOSS OF ANTICIPATED PROFITS, GOODWILL, REPUTATION, BUSINESS RECEIPTS OR CONTRACTS, COSTS OF PROCUREMENT OF SUBSTITUTE GOODS OR SERVICES; LOSS OF USE, DATA, OR PROFITS; OR BUSINESS INTERRUPTION), LOSSES OR EXPENSES RESULTING FROM THIRD PARTY CLAIMS. THESE LIMITATIONS WILL APPLY REGARDLESS OF THE FORM OF ACTION, WHETHER UNDER STATUTE, IN CONTRACT OR TORT INCLUDING NEGLIGENCE OR ANY OTHER FORM OF ACTION AND WHETHER OR NOT DECAWAVE HAS BEEN ADVISED OF THE POSSIBILITY OF SUCH DAMAGES, ARISING IN ANY WAY OUT OF DECAWAVE SOFTWARE OR THE USE OF DECAWAVE SOFTWARE.

You are authorized to use Decawave Software in your end products and to modify the Decawave Software in the development of your end products. HOWEVER, NO OTHER LICENSE, EXPRESS OR IMPLIED, BY ESTOPPEL OR OTHERWISE TO ANY OTHER DECAWAVE INTELLECTUAL PROPERTY RIGHT, AND NO LICENSE TO ANY THIRD PARTY TECHNOLOGY OR INTELLECTUAL PROPERTY RIGHT, IS GRANTED HEREIN, including but not limited to any patent right, copyright, mask work right, or other intellectual property right relating to any combination, machine, or process in which Decawave semiconductor products or Decawave Software are used.

You acknowledge and agree that you are solely responsible for compliance with all legal, regulatory and safety-related requirements concerning your products, and any use of Decawave Software in your applications, notwithstanding any applications-related information or support that may be provided by Decawave.

Decawave reserves the right to make corrections, enhancements, improvements and other changes to its software at any time.

Mailing address: -  
Decawave Ltd.,  
Adelaide Chambers,  
Peter Street,  
Dublin 8

**Contents**

1 INTRODUCTION .....7

    1.1 DecaRanging capabilities .....8

    1.2 DecaRanging control of the DW1000 transceiver .....8

2 INSTALLATION AND SET-UP .....10

    2.1 USB virtual COM: port software installation .....10

    2.2 Cheetah Driver Installation – OPTIONAL .....12

    2.3 DecaRanging Application Installation .....13

        2.3.1 Installation of Runtime Environment for Visual C++ .....13

    2.4 System Setup .....14

3 RUNNING THE DECAWAVE RANGING TEST APPLICATION .....15

    3.1 Running DecaRanging .....15

        3.1.1 Ranging Method Explained .....16

        3.1.2 Running *DecaRanging* (continued) .....17

        3.1.3 Pairing Method Explained .....17

        3.1.4 Running *DecaRanging* (continued again) .....18

        3.1.5 Setting the role .....19

    3.2 DecaRanging Main Window Display and Controls .....20

        3.2.1 Status and Statistics report .....20

        3.2.2 Main Controls .....22

    3.3 Configuration – Channel Setup .....24

    3.4 Configuration – Timing Setup .....25

    3.5 View – Channel Response View Enable .....27

    3.6 View – Display Distance in Feet and Inches .....29

    3.7 View – Large Text Range Display Enable .....29

3.8	View – Display Clock Offset .....	29
3.9	Debug – Register Access .....	29
3.10	Debug – Log Channel Responses .....	30
3.11	Debug – Log SPI Activity .....	30
3.12	Debug – Soft Reset (and Restart) .....	30
3.13	Debug – Continuous Frame Mode.....	30
3.14	Debug – Continuous Wave Mode.....	31
3.15	Keyboard shortcuts.....	31
3.16	Troubleshooting .....	31
4	APPENDIX 1 – Channel Response Log.....	33
4.1	Log File Header .....	33
4.2	TX Timestamps .....	34
4.3	RX Timestamps .....	34
4.4	RX Data .....	34
4.5	Channel Impulse Response (CIR) Data.....	35
4.6	ToF Data.....	36
	APPENDIX 2 – BIBLIOGRAPHY:.....	38
5	DOCUMENT HISTORY .....	39
6	MAJOR CHANGES.....	39
7	ABOUT DECAWAVE.....	39

## 1 INTRODUCTION

Decawave's *DecaRanging* is a demonstration application that drives Decawave's DW1000 integrated circuit, to demonstrate the accurate range measurement can be made between a pair of DW1000 units using a technique called two-way ranging. The DW1000 is a single chip RF transceiver supporting the IEEE 802.15.4 UWB PHY standard. Decawave supplies the EVK1000 kit, comprised of two DW1000 evaluation boards (EVB1000 boards) for use in conjunction with this application.

This document covers the version of Decawave's *DecaRanging* software that runs on a windows PC, describing how to install the software, how to run it, and how to interpret its results. It also discusses the basic operation of the two-way ranging algorithm being employed to measure the range.

The DW1000 evaluation boards (EVB1000) are supplied as a pair in a kit (EVK1000). The EVB100 boards have an on-board ARM microcontroller, with a preinstalled ARM version of *DecaRanging*, allowing them to run autonomously as a pair (once powered up) performing two-way ranging and displaying the range result on their on-board LCD. Please refer to the [EVK1000 User Manual](#) document for details of how to use, configure and interface to the DW1000 evaluation kit boards.

The *DecaRanging* PC application offers an alternative to the ARM embedded *DecaRanging* application allowing for additional configuration and diagnostic display possibilities. A DW1000 controlled by the *DecaRanging* PC application, can perform two-way ranging to another DW1000 controlled by either the *DecaRanging* PC application or the *DecaRanging* ARM application.

There are two ways for the *DecaRanging* PC application to connect and control the DW1000 IC on the DW1000 evaluation boards. That is either via the USB interface or via the SPI interface header (and employing a *Cheetah* USB-to-SPI convertor). Please refer to section [1.2 – DecaRanging control of the DW1000 transceiver](#) for more details. In either case the *DecaRanging* PC application essentially has control of the DW1000 which it drives to exchange messages between a pair of devices, calculate the time-of-flight of those messages and display the resultant distance between the two units.

The pre-built *DecaRanging* PC application (DecaRanging.exe) is built to run on a 32-bit windows PC. Decawave can facilitate customers who wish to drive the DW1000 from their own microprocessor system by providing the source code for ARM version of the *DecaRanging* application.

## 1.1 DecaRanging capabilities

The *DecaRanging* application enables the following DW1000 capabilities to be observed and tested:

- a) General operation of Decawave's 802.15.4 UWB transceiver IC on the supported channels and modes as it sends and receives data frames.
  - IEEE specified preamble codes are supported giving complex channels as per standard
  - Data Rates: 110 kbits/s, 850 kbits/s and 6.8 Mbits/s
  - Mean nominal Pulse Repetition Frequencies (PRF) of 16 MHz and 64 MHz
  - Preamble lengths or Preamble Symbol Repetitions (PSR) from 64 to 4096 symbols
- b) Line-of-Sight (LOS) Range. The operator can check the operational range as the receiver is placed at various distances in LOS from the transmitter. This may be tested in all supported modes.
- c) Non-line-of-Sight (NLOS) Range. The operator can check operational range when various obstructions are between the receiver and the transmitter giving a NLOS channel. This may be tested in all supported modes.
- d) Time-of-Flight Ranging Measurements. The *DecaRanging* application performs 2-way ranging between two DW1000 transceivers (EVB1000 evaluation boards), and estimates the distance between them based on the time-of-flight calculations. The operator can check how the distance estimate changes as the two units are moved nearer/further from each other, and when there are walls and other obstructions between the units. Again, this may be tested in all supported modes.

## 1.2 DecaRanging control of the DW1000 transceiver

The DW1000 is controlled via its SPI bus. There are two ways for the *DecaRanging* PC application to connect and control the DW1000 IC on the DW1000 evaluation boards:

- a) Via the USB interface – The EVB1000's on-board ARM microcontroller's a preinstalled application can operate as a simple USB to SPI controller, passing the *DecaRanging* PC applications SPI accesses to/from the DW1000 IC. Please refer to the [EVK1000 User Manual](#) document for details of how to configure and enable this mode of operation.
- b) Via the SPI interface header – The [EVK1000 User Manual](#) document for details of how to configure EVB1000 for DW1000 direct SPI access. The *DecaRanging* PC application can optionally employ a *Cheetah* USB-to-SPI convertor control the DW1000 IC directly. This is a legacy operation supported on earlier versions of *DecaRanging*. The *Cheetah*<sup>1</sup> USB-to-SPI convertor is a commercial product of Total Phase, Inc. This mode of operation may be useful to control the DW1000 on a customer developed board (through a suitable header or wiring) to validate the board performance compared to the EVB1000.

---

<sup>1</sup> Cheetah SPI Host Adapter - These are available from [http://www.totalphase.com/products/cheetah\\_spi/](http://www.totalphase.com/products/cheetah_spi/) for USD \$350.



Whichever SPI connection method is employed, the *DecaRanging* PC application essentially directly controls the DW1000 transceiver to exchange messages, calculate their time-of-flight and display the resultant distance between a pair of units.

So, the DecaRanging demo application is supported running on the EVB1000’s on-board ARM microcontroller, or on a Windows PC where it can either use USB virtual com port connection to the EVB1000’s software USB-to-SPI conversion, or, use a *Cheetah* USB-to-SPI converter and connect to the EVB1000 via the SPI header. All these modes are inter-operable, however when the PC application ranging to an ARM controlled board is used the ARM side has to be a tag. Two EVB1000 evaluation units along with two *DecaRanging* applications (PC or ARM) allows the DW1000 transceiver’s capabilities to be demonstrated and verified, the operating arrangement options are shown in Figure 1.

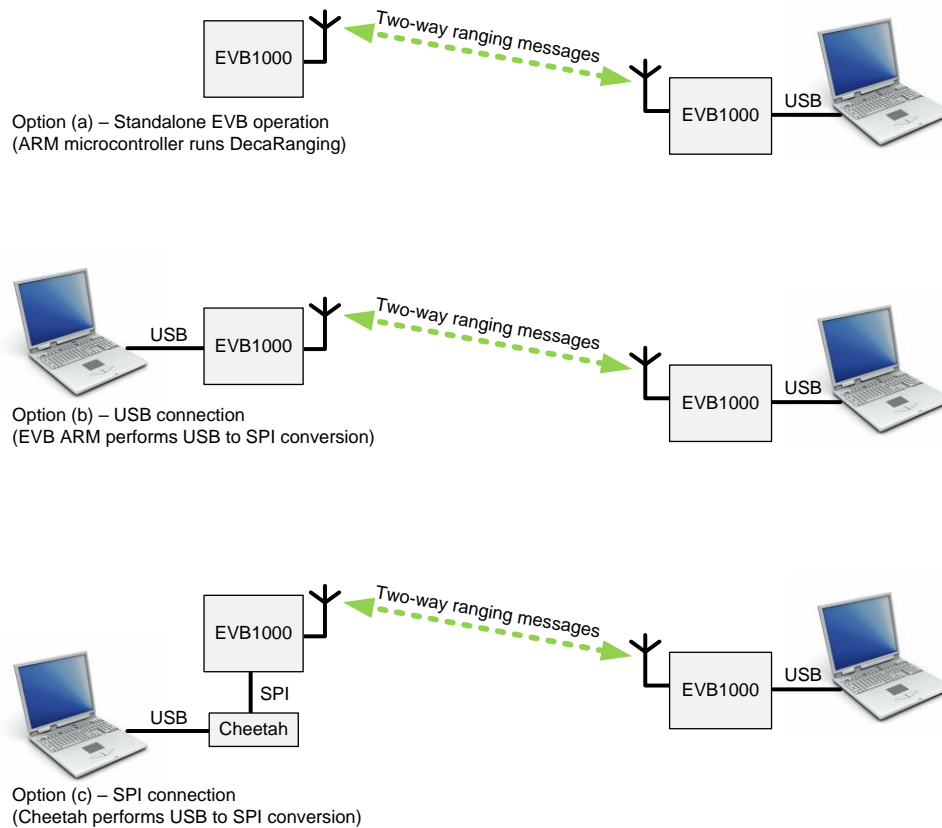

**Figure 1 – DecaRanging operating arrangement options**

Note: In Figure 1 the right-hand side unit is shown as per the arrangement of option (b) but it too may also be either of options (a) or (c). For details of the EVB1000 standalone operation, please refer to the [EVK1000 User Manual](#). In (a) the PC side has to be the anchor mode.

## 2 INSTALLATION AND SET-UP

This installation and setup chapter deals only with the PC version of DecaRanging and the PC software drivers that are necessary for its operation. The reader should also consult the [EVK1000 User Manual](#) document for details of how to configure and use the EVB1000 boards.

Additional documentation available from Decawave deals with the ARM version of the DecaRanging application.

### 2.1 USB virtual COM: port software installation

This section describes how to install the software to allow the PC to connect to the EVB1000 USB port and employ the EVB1000’s ARM software USB-to-SPI conversion to drive the DW1000 IC. The windows PC driver is available from the ST Microelectronics website at:

<http://www.st.com/web/en/catalog/tools/FM147/CL1794/SC961/SS1533/PF257938>

[http://www.st.com/content/st\\_com/en/products/development-tools/software-development-tools/stm32-software-development-tools/stm32-utilities/stsw-stm32102.html](http://www.st.com/content/st_com/en/products/development-tools/software-development-tools/stm32-software-development-tools/stm32-utilities/stsw-stm32102.html)

**STSW-STM32102** ACTIVE

STM32 Virtual COM Port Driver

DESIGN
GET SOFTWARE

DESIGN

Legal

License Agreement

	Description	Version	Size
	SLA0044: LIBERTY V2 - Software license agreement	4.4	105 KB

GET SOFTWARE

Part Number	Software Version	Marketing Status	Supplier	Order from ST
STSW-STM32102	1.4.0	Active	ST	<span style="background-color: #0070c0; color: white; padding: 2px 5px; border-radius: 3px;">Get Software</span>

**Figure 2 – partial screen capture from ST Microelectronics website**

Click the download button to download the “stsw-stm32102.zip” file containing the driver. Inside the ZIP file is the installation program for both 32-bit and 64-bit versions of Windows (VCP\_V1.4.0\_Setup.exe) and installation instructions. Run the program and install the driver.

**Note: Sometimes the driver may not be installed but executable copied into: \Program Files (x86)\STMicroelectronics\Software\Virtual COM Port Driver\. You need to then go to that folder and click on the executable to install the driver.**

We have successfully employed this driver on Windows-XP, Windows-7 and Windows-8 computers.

After this installation, when the EVB1000 is configured for USB to SPI operation and connected to the PC via the USB port it should be correctly recognised configured as a virtual com port. To allow time for the EVB1000 to start-up and be recognised by the PC and made ready for operation as virtual com port, after any insertion of the EVB1000 USB, please wait for 10 seconds before running the DecaRanging PC application.

**Note: the virtual com port number needs to be between 3 and 49. Please change the port number through Control Panel\Hardware and Sound\Device Manager, select Ports and Properties, then \Port Settings – Advanced, as shown in Figure 3 and Figure 4.**

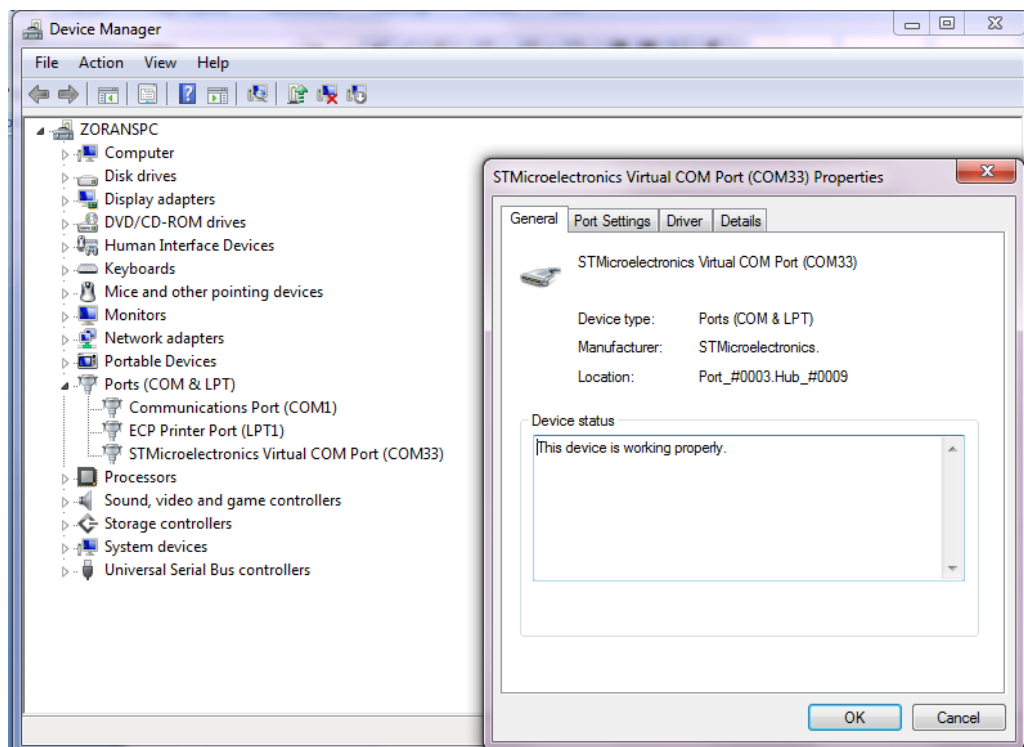

Figure 3 - COM port configuration - properties window

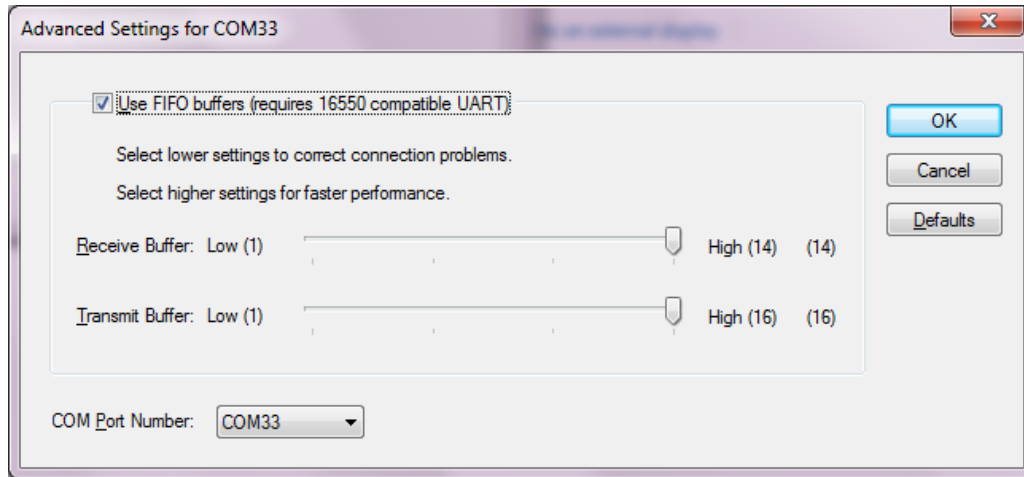

Figure 4 - Advanced settings for COM port

## 2.2 Cheetah Driver Installation – OPTIONAL

Driving the EVB1000 from the *DecaRanging* PC application using the *Cheetah* USB-to-SPI convertor is a legacy operation supported on earlier versions of *DecaRanging*. The EVB on-board USB-to-SPI conversion functionality was added to allow this same direct control avoid having to purchase *Cheetah* devices. Operation with *Cheetah* has been retained to allow *Cheetah* usage, to validate the SPI port on the EVB1000 and to allow the *DecaRanging* PC application to drive the DW1000 on a customer developed board that expose the appropriate access to the SPI port. This may be useful to validate the customer board performance against that of the EVB1000.

The *Cheetah* USB drivers are supplied by Total Phase Inc. with the *Cheetah* adaptors. Use the USB driver supplied on the CD that comes with the *Cheetah* adaptor to install the USB drivers. This is also available from the Total Phase web-site at: <http://www.totalphase.com>. The installation should be done with the *Cheetah* disconnected from the PC's USB port. Please follow the installation instructions from Total Phase.

Please refer to the [EVK1000 User Manual](#) document for details of how to configure the EVB1000 boards for SPI port access and connect the cheetah.

## 2.3 DecaRanging Application Installation

The *DecaRanging* application installation is a manual process:

- Simply copy the file [DecaRanging.exe](#) to the desired directory on your windows PC hard-drive.
- Optionally copy the file [cheetah.dll](#) to the same directory if you want to use a *Cheetah* USB-to-SPI convertor

### 2.3.1 Installation of Runtime Environment for Visual C++

To run *DecaRanging.exe* on a computer that does not have Visual C++ 2010 installed, the runtime libraries, “Microsoft Visual C++ 2010 Redistributable Package (x86)” available from Microsoft need to be installed. These are available at:

<http://www.microsoft.com/en-us/download/details.aspx?id=5555>

Please download and run the [vc redistrib\\_x86.exe](#) installation program to install the runtime libraries necessary to prepare your system to run the *DecaRanging* application.

## 2.4 System Setup

Figure 1 showed the various operational scenarios supported by the system, for the purposes of this discussion about the *DecaRanging* PC application clearly at least one end must be the EVB1000 driven by this application (direct USB or via Cheetah) while the other end could be either the EVB1000 in standalone mode or the EVB1000 also driven by this the *DecaRanging* PC application. Both these options are covered in the discussion below.

If the software has been installed following instructions above and the PC is connected to the EVB1000 in one of the arrangements shown in Figure 1, (and following instructions in the [EVK1000 User Manual](#)) then everything should be ready to go.

Section 3 below details running the *DecaRanging* application.

### 3 RUNNING THE DECAWAVE RANGING TEST APPLICATION

The *DecaRanging* two-way ranging demonstration application is Microsoft Windows™ software. Chapter 1 – *INTRODUCTION* gives an overview of the capabilities of the *DecaRanging* software and chapter 2 – *INSTALLATION AND SET-UP* describes the installation. This chapter describes the runtime operation of the *DecaRanging* application and its user configurations and controls.

#### 3.1 Running DecaRanging

When the *DecaRanging.exe* executable is run on the PC, the main display window shown below is opened.<sup>2</sup>

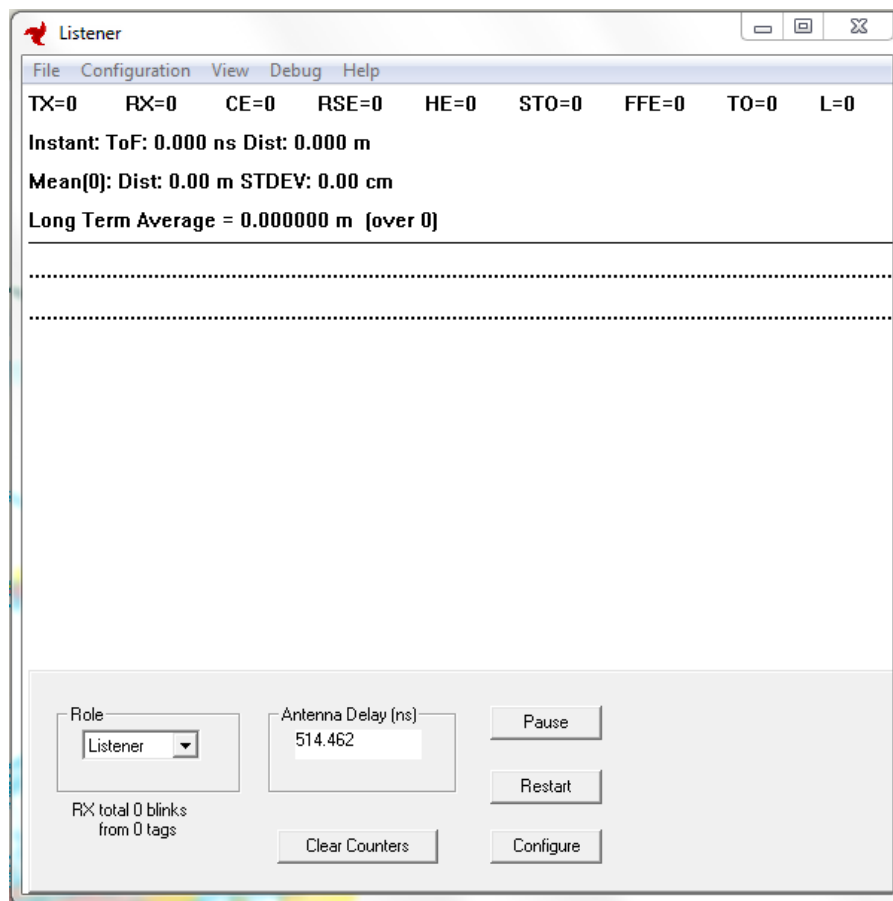

Figure 5 - DecaRanging main screen

Before going any further a brief discussion of the ranging method employed is necessary to understand the operation of the *DecaRanging* application. This is covered in section 3.1.1 directly following below.

<sup>2</sup> This assumes that communications with the EVB1000 is established. For troubleshooting see section 3.16.

### 3.1.1 Ranging Method Explained

The ranging method uses a set of three messages to complete two-round trip measurements from which the range is calculated. As messages are sent and received the *DecaRanging* application retrieves the message send and receive times from the DW1000. These transmit and receive timestamps are used to work out a round trip delay and calculate the range.

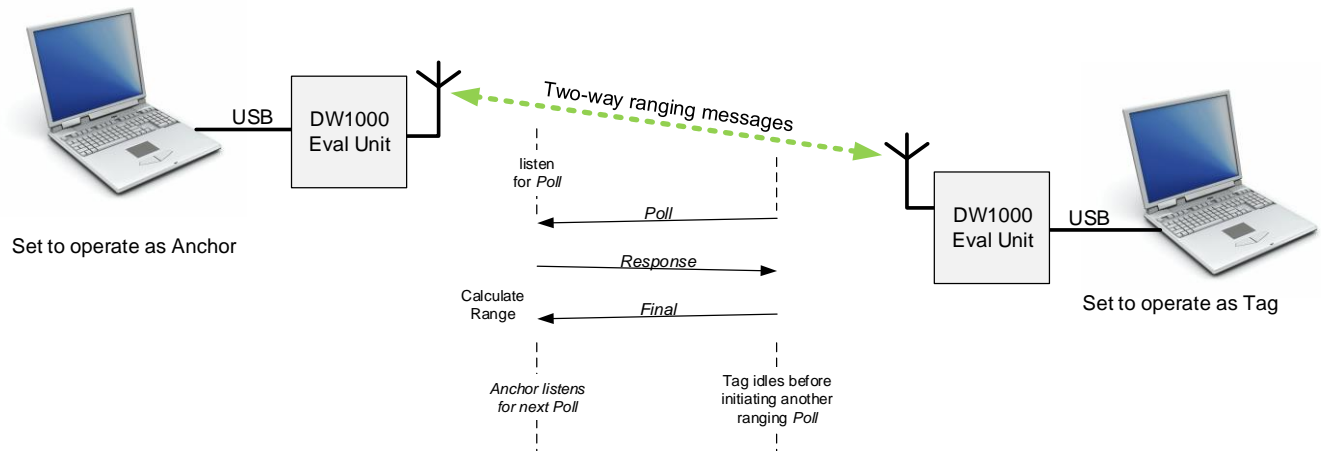
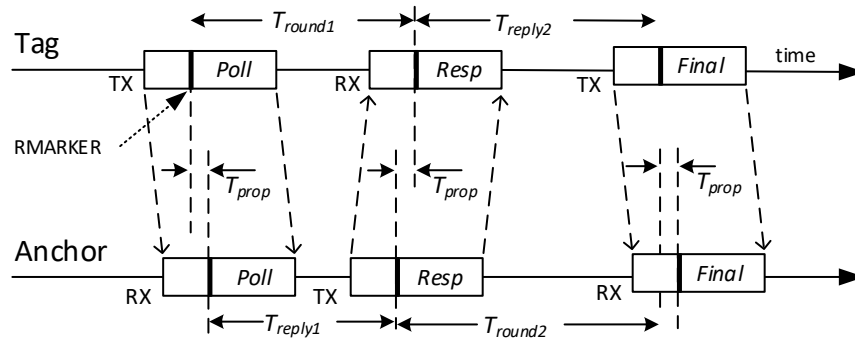

Figure 6 - ranging message exchange

In the ranging algorithm there are two roles, one end is nominated to act as a TAG and the other end is nominated to act as an ANCHOR. The anchor is predominately listening for a message from the tag. A single ranging operation is initiated by the tag sending a poll message. When the anchor receives the poll it sends a response message. The tag then receives the response message and sends a final message with embedded transmit and receive timestamps for the poll, response and the final message itself. The anchor uses this information along with its own transmission and reception timestamps to calculate two round trip times which are used to get the one-hop time-of-flight which equates to the distance when multiplied by the speed-of-light (e.g. the speed of the radio waves) in air.

The anchor uses the response message to send a report of the previous calculated range back to the tag so both ends have a result that can be displayed. In a practical use of this algorithm this report may not be necessary or maybe implemented through a specific message.





The *Final* message communicates the tag's  $T_{round}$  and  $T_{reply}$  times to the anchor, which calculates the range to the tag as follows:

$$T_{prop} = \frac{T_{round1} \times T_{round2} - T_{reply1} \times T_{reply2}}{T_{round1} + T_{round2} + T_{reply1} + T_{reply2}}$$

Figure 7 - range calculation

### 3.1.2 Running DecaRanging (continued)

Initially when the [DecaRanging.exe](#) executable is run, the software starts in listener mode where it listens and reports all received messages. In running *DecaRanging* and performing the ranging message exchanges, one end needs to take the role of an Anchor while the other end needs to take the role of a Tag, however because the ranging messages include both source and destination addresses a discovery mechanism is needed for tag and anchor to learn each other's addresses and become paired. This is done according to the pairing method explained in section 3.1.3 below.

### 3.1.3 Pairing Method Explained

Initially the unpaired anchor and tag are in a discovery phase where the unpaired tag sends a Blink message that contains its own address, after which it listens for a Ranging Initiation response from an anchor. If it does not get one it waits for a period (default value of 1 second) before "blinking" again. The unpaired anchor listens for tag blink messages. The anchor end decides to pair with a tag and sends the Ranging Initiation message to exit from the Discovery Phase and enter the Ranging phase.

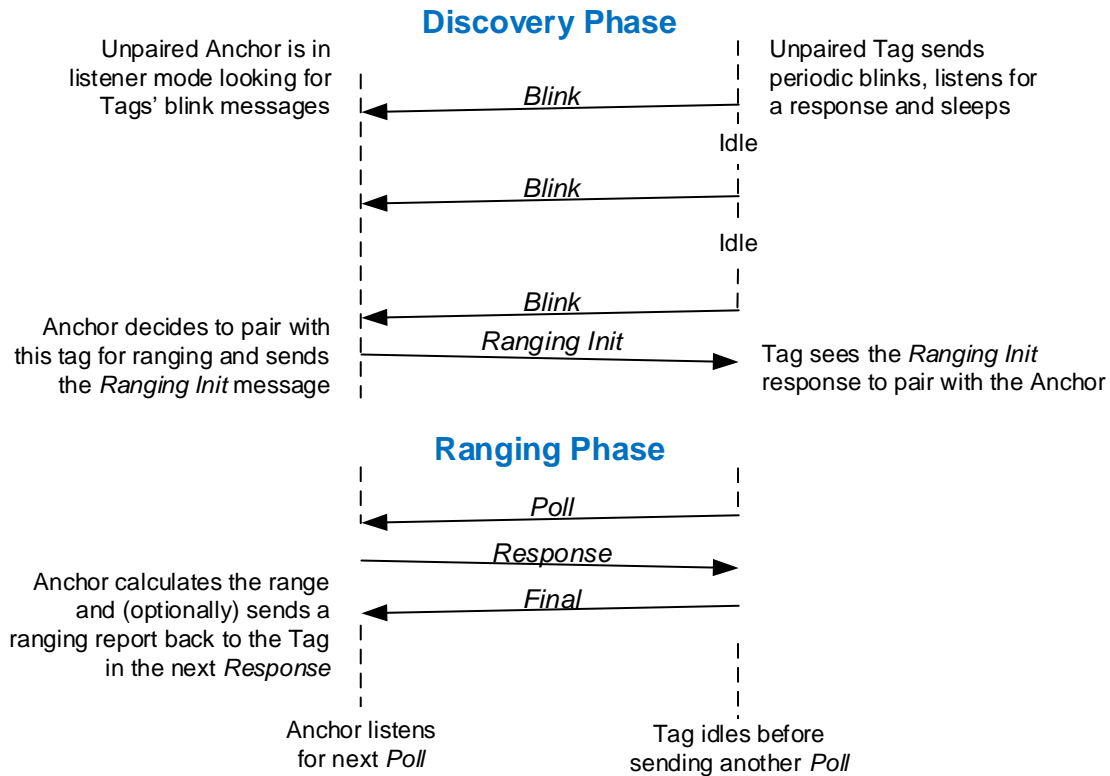

Figure 8 – progression from discovery phase to ranging phase

In the PC *DecaRanging* the program stays in *Listener* mode and reports number of blinks received. The user must choose the tag to range with when changing into *Anchor* mode. In the ARM based *DecaRanging* the board configured to be the anchor automatically transitions to into *Anchor* mode ranging with the tag whose blink is received first.

### 3.1.4 Running *DecaRanging* (continued again)

If both tag and anchor ends are to be paired using PC *DecaRanging* then one end should be set to take on the role of a tag, while the other end should remain in the listener role until some tag blinks are seen, before changing into the anchor role to complete the discovery phase and enter the ranging phase of the operation. Setting the role is covered in section 3.1.5 below.

### 3.1.5 Setting the role

To enable the ranging function the user must reconfigure one of the ends to be the Tag and then the other to Anchor (after the anchor has received some tag blinks). This role configuration is done using the drop-down list of the Role group to the bottom left of the main *DecaRanging* window.



Figure 9 - role selection

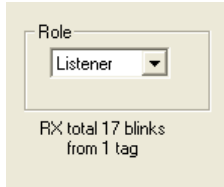

Note, as described above, the anchor needs to spend some time in the initial Listener role to receive some blink messages from the tag before being taking on the Anchor role. The number of blinks received is reported in text just under the Role selection control.

Figure 10 – blink RX report

Assuming some blinks have been received then, when anchor mode is selected an additional dialog box opens wherein the tag may be selected via its address. Use the drop-down list to select which tag this anchor should pair and communicate with during the ranging phase.

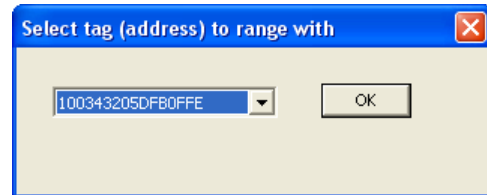

Figure 11 – tag selection by address

#### 3.1.5.1 Listener role

In listener mode the software keeps the receiver turned on and reports (in the area above the main control panel) the contents of the received frames as simple hex dump of the frame octets. This scrolls up with the newest arriving frame displayed at the bottom. The bracketed number on the left is the frame length.

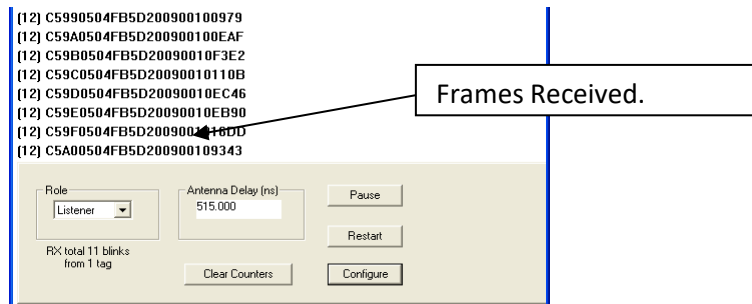

Figure 12 – received frame display in listener mode

Note: In this software the DW1000 IC's double buffering is not enabled, so the receiver stops every time a frame is received. This is to allow reading of the accumulator data for graphical display (see section 3.5 below) which would otherwise be lost if the receiver was re-enabled. After the PC has read the accumulator data the receiver is re-enabled. The effect of this is that listener mode will not see frames that are arriving in close proximity to one another, i.e. frames arriving between a first frame arrival and the receiver being re-enabled.

#### 3.1.5.2 Tag role

In tag mode (after selection or reset) the tag waits for 1000 ms (by default) and then sends a blink message and listens for a "Ranging Init" response from the anchor to initiate pairing. The tag will return to idle if no response is received. When the "Ranging Init" response is received, the tag is paired with the responding anchor. Once paired the tag will wait for 1000 ms (by default), and then initiates a ranging exchange.

The two periods mentioned above can be altered via the timing configuration dialog (see section 3.4 below).

#### 3.1.5.3 Anchor role

After being in Listener mode and receiving some tag blinks the user may set anchor mode, and select the tag to pair with. After this the anchor remains with its receiver enabled waiting for a poll message from the selected tag, to initiate another two-way ranging exchange.

The result of each two-way ranging is a distance estimate displayed on the anchor screen. The ranging result is also sent back to the tag end for it to display, through the response message of next ranging exchange.

The user controls available within the *DecaRanging* PC application are described below.

## 3.2 DecaRanging Main Window Display and Controls

This section discusses the main elements of operation and functionality available in the *DecaRanging* test and demonstration application.

### 3.2.1 Status and Statistics report

When the ranging is running the lines at the top of the main window give a status report that indicates count of frames successfully sent and received, and also reports current most recent ranging measurements performed. Figure 13 is a screen capture to show what this might look like in an anchor after a number of messages are exchanged.

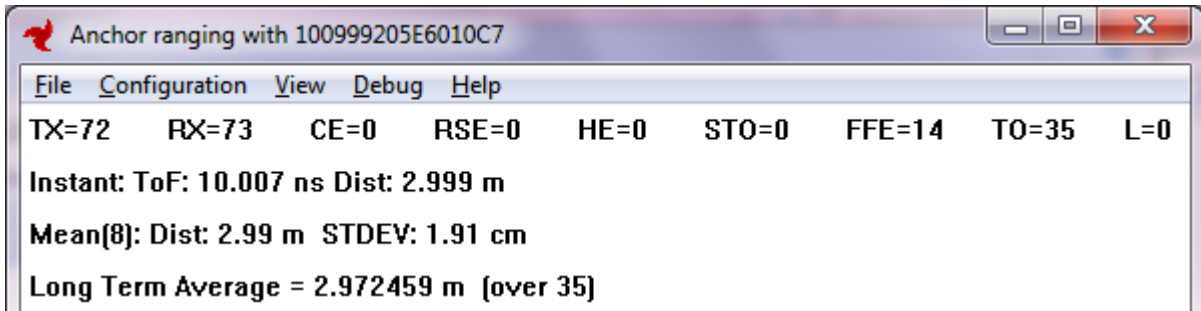

Figure 13 - status and statistics panel

The status information of Figure 13 is described below with reference to the Figure 14 where the red text is used to identify the changing numeric values reported by the application.

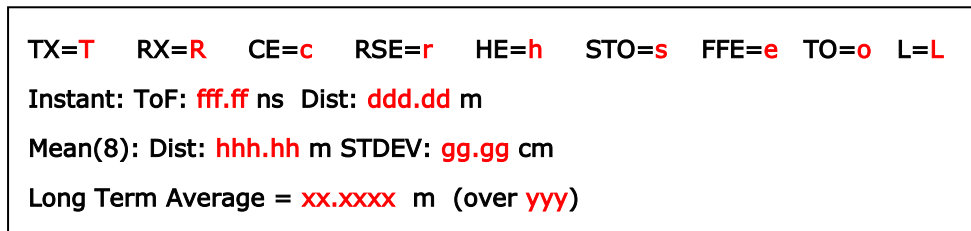

Figure 14 - status and statistics panel fields

On the first line then:

- Value **T** is the number of frames transmitted.
- Value **R** is the number of frames received, (with good CRC).
- Value **c** is a count of CRC errors.
- Value **r** is a count of unrecoverable errors in the Reed Solomon decoder.
- Value **h** is count of uncorrectable errors detected in the PHY header SECDED code.
- Value **s** is count of SFD timeout events.
- Value **e** is the number of frame filtering errors. (These will occur if the destination address is incorrect i.e. not for this device).
- Value **o** is the number of times the Tag has timed out from receiving without getting a response frame. This results in another transmission attempt, (incrementing **T**).
- Value **L** is a count of late TX enables and late RX enables. These can occur in the delayed transmission and reception. If this happens frequently (and not as a result of user menu activity) then it probably means that the response time configuration needs to be increased.

The 2<sup>nd</sup> and 3<sup>rd</sup> lines are similar in function, except that while the 2<sup>nd</sup> line reports a single instantaneous value, the 3<sup>rd</sup> line reports a mean (or average) value. On these 2<sup>nd</sup> and 3<sup>rd</sup> lines then:

- Value **fff.ff** is the measured time of flight in nanoseconds.
- Value **ddd.dd** is distance in metres. This is value **fff.ff** multiplied by 299,702,547.0 which is the speed of light in air.
- Value **gg.gg** is the standard deviation of the calculated distance (of last 50 range values) in centimetres.

The averaging of the 3<sup>rd</sup> line is the mean of the last eight values (**hhh.hh**).

The 4<sup>th</sup> line is reports a long term average of the instantaneous distance measurements, giving the average value **xx.xxxx** in metres, and indicating over how many readings **yyy** this has been averaged.

**NOTE:** The distance estimates are from antenna to antenna, see section 3.2.2.3 for details of antenna delay setting.

**NOTE:** With respect to the receiver error conditions counted above: An SFD timeout typically results from a false detection of preamble, where the subsequent expected SFD is not detected. PHY header errors may result from either a real error in the PHR or, after a false detection of preamble and/or SFD. Reed Solomon errors and CRC errors indicate problems in data recovery. Typically frame reception is aborted at the earliest error detected so CRC error may not be counted if an earlier PHR or Reed Solomon has already aborted reception.

### 3.2.2 Main Controls

The main controls are in a panel on the bottom of the main window.

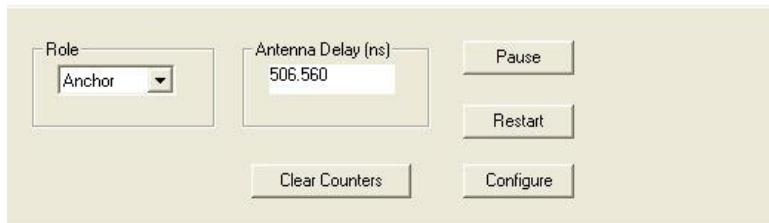



Figure 15 - main controls

#### 3.2.2.1 Role

The *Role* group is used to select whether the application acts as the Listener, Tag or Anchor. Role selection is covered in section 3.1.5 above.

#### 3.2.2.2 Restart

The  button may be used at any time to reset the software and start again. There is also a “Soft Reset (and Restart)” option, see section 3.12, which additionally performs an IC reset.

### 3.2.2.3 Antenna Delay

The antenna delay entry box is designed to allow for setting the delays to and from the antenna so that these may be subtracted from the round trip. The value specified here is used to correct the reported message send and receive times, half in the transmitter and half in the receiver, compensating for the system delays between physical timestamp and signal presence at the antenna.

**NOTE: When changing this value on a Tag instance the application needs to be PAUSED first. (Press the  button before changing the value.) If this is not done the value will not be correctly applied.**

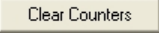
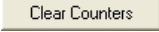

In the EVK1000 kits the boards are delivered with a calibrated antenna delay programmed into the IC’s one-time-programmable (OTP) configuration memory, and the configured value is displayed in the antenna delay panel. (If an OTP value is not set a default antenna delay value embedded in the *DecaRanging* application is used).

The value can be recalibrated if necessary (e.g. due to change in antenna) as follows:

- a) Position the two units some distance apart (not too close, say 8 metres apart).
- b) Run the *DecaRanging* application at each end setting one to the Tag and the other to Anchor role so that ranging is done and range measurements are being reported.
- c) Using a tape measure, accurately measure the antenna to antenna distance between the antennas of the two units. Without disturbing the boards.
- d) Use the  button to clear the measurement averages. Without obstructing the line-of-sight path between the units, observe the reported range average converges to a good agreement with the tape measured value. If it doesn’t, then it is possible to change the antenna delay value to improve this. The value is a decimal value in nanoseconds. After typing new value use “Enter” key to apply the change. Each nanosecond change (when applied at both ends) gives 30 cm difference in range.
- e) It is recommended that the same value is programmed at each end. After the antenna delay is changed (at both ends), the  button can be used to clear the measurements, and the long term average can be observed to verify that the new antenna delay setting is giving a better average distance measurement agreeing with the manually measured distance.

Note: Antenna delay is actually two values – the value shown/edited at a 16 MHz PRF configuration is separate to value shown/edited when the PRF is reconfigured to 64 MHz.

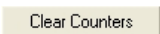
### 3.2.2.4 Other Main Panel Buttons

The other main panel buttons are fairly self explanatory. The  button clears the counters and values reported on the status lines, as described in section 3.2.1 above. The  button disables all activity in the

lower layer application state machine, essentially halting all sending and all receive processing. When the pause is active the Pause button changes to a **Resume** button which may be used to resume activity. The **Configure** button opens the Channel Setup dialog, (see section 3.3 below for details), which is the same dialog reached via Configuration – Channel Setup menu.

### 3.3 Configuration – Channel Setup

This section describes the configurable items that appear on the Channel Setup dialog box accessed via either the main panel **Configure** button or via the Configuration menu’s *Channel Setup* option. Figure 16 shows the Channel Setup dialog box.

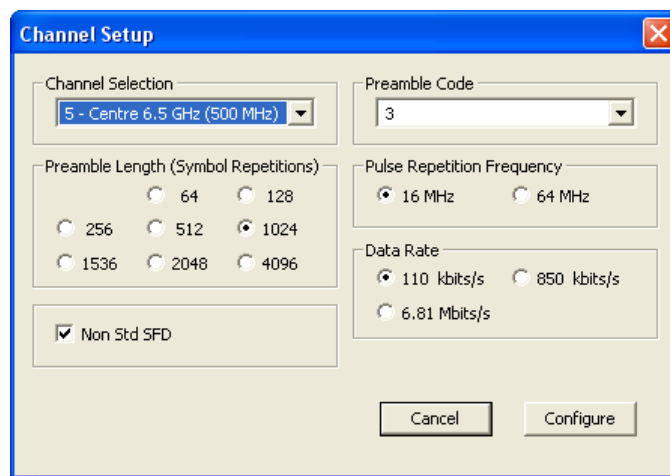

Figure 16 – channel setup configuration dialog box



The Channel Setup dialog box allows for the configuration of all the parameters controlling the format of 802.15.4 messages. The configurable items are described in Table 1 below.

Table 1 - channel setup dialog elements

Item	Description and Notes
Channel Selection	This is a drop down list for selection of the operating channel. The applicable centre frequency and bandwidth is also shown for convenience.
Preamble code	The Channel Selection in conjunction with the configured Preamble Code defines the <i>Complex Channel</i> for the inter device communication. The preamble codes offered in this drop-down list change depending on the Channel Selection  NB: For good communication and ranging, both units must have the same Complex Channel configurations.

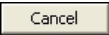

Item	Description and Notes
Preamble length	<p>The preamble length is set here. Longer preambles make it easier for the receiver to lock to the message improving the channel matching and the first path determination, hence increasing the viable communications range and the accuracy of ranging measurements at that communications range.</p> <p>Preamble lengths of 64, 1024 and 4096 are defined in the IEEE 802.15.4 standard. The additional preamble lengths provided by the DW1000 allow designers more opportunity to optimise system performance trade-offs.</p> <p>Ideally the same preamble length should be set at both ends to give a balanced communications range, set to be consistent with the data rate. For long range at the 110 kbps data rate one would use a preamble of 1024 (or more) symbols, while at the 6.8 Mbps data rate a long preamble will bring no benefit and a shorter preamble would be used in practice to save power and air-time (increasing network capacity).</p>
Non Std SFD	<p>This tick box enables the use of a non-standard SFD. The SFD is the component of the IEEE 802.15.4 UWB frame marking the end of the preamble and the start of the data frame, which is actually a certain pattern of normal, inverted and deleted preamble symbols. Decawave has found an alternative SFD pattern that is more robust than the one defined in the IEEE 802.15.4 standard, giving an extra dB or so of performance.</p>
Pulse Repetition Frequency	<p>This selects the Pulse Repetition Frequency to be used in the transmitter and receiver. NB: both units need the same PRF configuration setting.</p>
Data Rate	<p>The data rate may be selected to be any one of the data rates available here. NB: both units need the same data rate setting.</p>

Two buttons are provided: (a) The  button to escape from and close the Channel Setup dialog without making any changes, and, (b) The  button to apply the changed configuration to the DW1000, which resets everything including the counters to start again with the modified configuration.

### 3.4 Configuration – Timing Setup

Timing configuration is selectable from Configuration menu's *Timing Setup* menu option

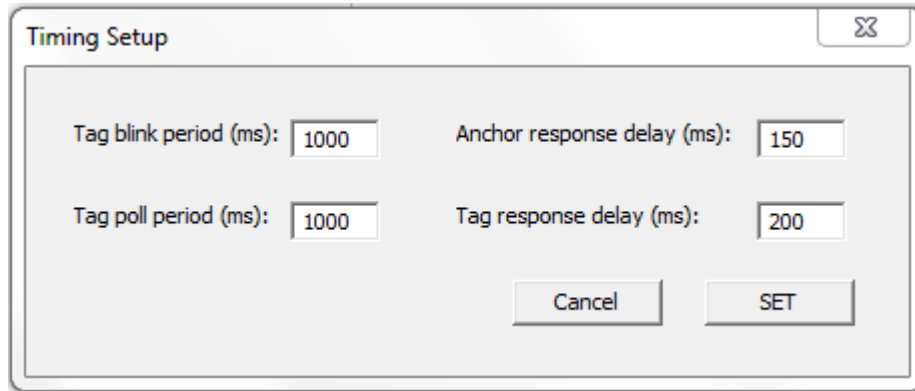

Figure 17 - Timing setup configuration

The timing setup dialog is used to configure certain parameters of the tag and anchor message interactions use during the two-way ranging measurement and reporting.

The configurable items are described in Table 2 below.

Table 2 - Timing setup dialog elements

Item	Description and Notes
Tag blink period:	This sets the time for which the tag waits between the blinks that are sent while the tag has not been paired with an anchor. See section 3.1.3 above for details.
Tag poll period:	This sets the time for which the tag waits between ranging attempts. See 3.1.1 above.
Anchor response delay:	<p>This sets the response delay used in anchor for sending the response to the tag poll message.</p> <p><b>This can be set only at anchor end and before a ranging exchange has been started.</b></p> <p>The time required relates to the responsiveness of the PC. The default 150 ms is good for most reasonably new machines. With older slower PC this may need to be increased to get reliable ranging interactions (e.g. a value of 300 ms might be sufficient). The “L=” error count in the status display may be an indication that the response time is too low. See 3.2.1 above. <b>The minimum value that can be set is 30 ms, this can work when using two Cheetahs to drive the EVBs.</b></p>

Item	Description and Notes
Tag response delay:	<p>This sets the response delay used in tag between receiving the anchor response and sending the final message.</p> <p><b>This can be set only at anchor end and before a ranging exchange has been started.</b></p> <p>The time required relates to the responsiveness of the PC. The default 200 ms is good for most reasonably new machines. With older slower PC this may need to be increased to get reliable ranging interactions (e.g. a value of 300 ms might be sufficient). The “L=” error count in the status display may be an indication that the response time is too low. See 3.2.1 above. <b>The minimum value that can be set is 30 ms, this can work when using two Cheetahs to drive the EVBs.</b></p>

NOTE: When working with EVB1000 version of DecaRanging running on ARM, the PC end must be the anchor.

### 3.5 View – Channel Response View Enable

Selecting the Channel Response View Enable opens a panel in the middle of the main window into which it the Channel Response values are drawn graphically. Figure 18 shows a typical channel impulse response graphic. The channel response is an array of complex values, the red line is the plot of the real values, the green line is the imaginary values, and the blue line is the computed magnitude values. This graphing shows the DW1000’s view of the channel impulse response. The graphic also indicates with a vertical orange line where the DW1000 finds the leading path. In normal operation of the DW1000 there is no need to access this channel impulse response data, which is quite a lot of data, doing so will slow down system responsiveness. The hardware reported RX timestamp is accurate and is all that is needed.

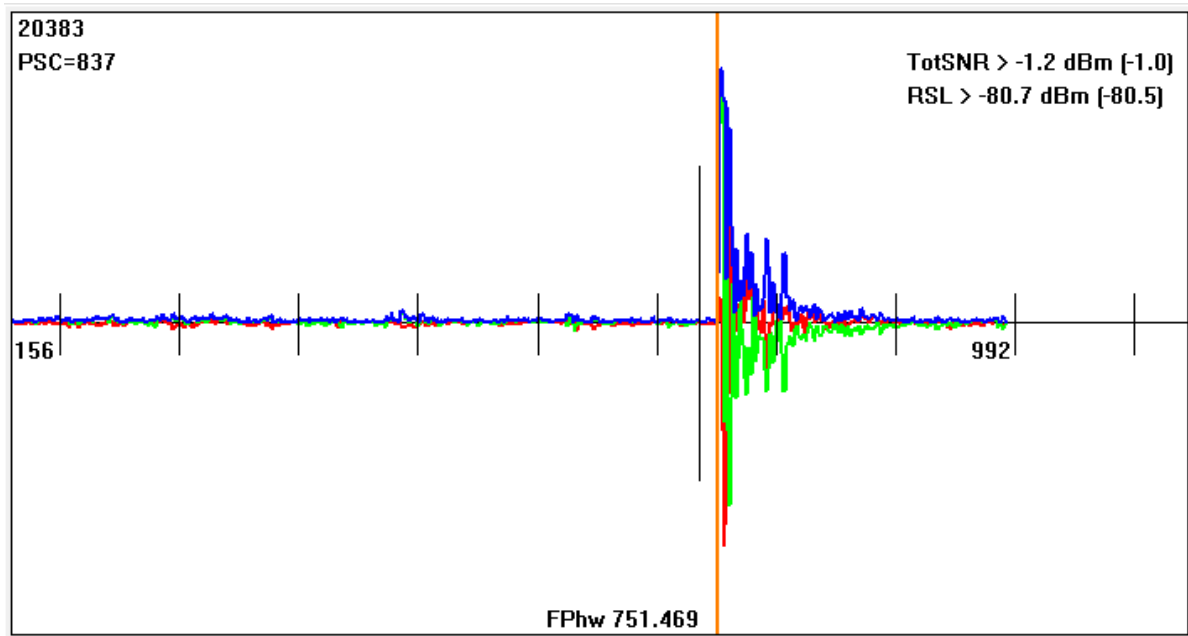

Figure 18 - channel response view

When the channel impulse response display is active, it is possible to zoom in and out using a mouse with a wheel. Make sure the *DecaRanging* application has focus (i.e. is the selected application). Then move the mouse pointer to a particular point over the graph and move the mouse wheel up (away from you) to zoom in on the X-coordinate frame. The zoom uses the mouse position to decide where to zoom. Move the wheel down (towards you) to zoom out again. Holding CTRL while moving the mouse wheel zooms on the Y scale. This Y zoom acts to keep the graph centred between selected  $-Y$  and  $+Y$  values, (i.e. max plus and minus are increased/decreased at the same rate).

The view menu has an option for *Channel Response First Path Align*, which is on by default. The view menu also has an option for *Channel Response Only Show Magnitudes* which is self explanatory. When zoomed in on the Magnitude Only display mode, markers indicating individual nanosecond sample intervals are added to the curve displayed. Deselecting Channel Response View removes the panel and stops the graphing display.

The top-left number is an indication of the height of display max-amplitude. The PSC number indicates the number of preamble symbols accumulated. The numbers below the mid line are accumulator index (nanosecond) values, while the FPhw value beside the orange line is the DW1000 IC reported leading path (sub-nanosecond) position. The SNR and RSL values are calculated from diagnostic values reported by the DW1000 (please refer to the DW1000 user manual for more details of these). Moving average of the last 10 values is reported beside their instantaneous value as shown in Figure 18.

### 3.6 View – Display Distance in Feet and Inches

Selecting this menu option appends a bracketed value in feet and inches to both *Instant:* and *Mean(8):* status lines, which is a conversion of the corresponding meter distance reported by each.

### 3.7 View – Large Text Range Display Enable

Selecting the Large Range Display Enable view menu option opens a panel in the middle of the main window into which the range (distance) estimates are displayed in metres using in a very larger font to make it clearly visible from a distance, especially when the window is maximised. The view menu has options to select the most prominent value (i.e. the largest figure shown at the top of the panel). The options are: the average of 8 range measurements (this is the default), the average of 4 range measurements or the instantaneous range measurement. There is also an option to set the precision of the value displayed to have 2 decimal places, instead of (the default) 1 decimal place.

### 3.8 View – Display Clock Offset

Selecting the Display Clock Offset, will display the clock offset in ppm between the two ranging units. This menu can only be turned on in the anchor instance as the anchor calculates the offset after reception of the final message. Note: the clock offset result is only valid in good line of sight conditions, where the distance report is stable.

### 3.9 Debug – Register Access

This is a facility sometimes used by Decawave engineers for debug purposes. In general it is NOT recommend for customers to experiment with this unless directed to do so by Decawave support engineers. Selecting the *Debug - Register Access* menu opens the Low-Level Register Access dialog.

Debug Register Access is only allowed when the normal operation has been suspended, i.e. paused using the  button in the main control panel – if this is not done then the *Register Access* menu item will be greyed out and unavailable.

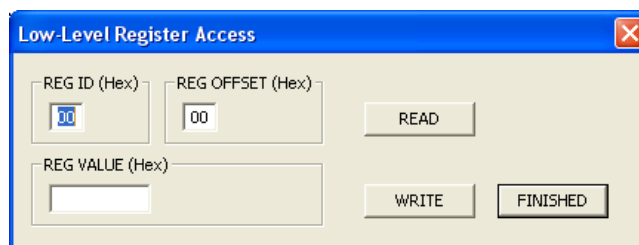

Figure 19 - low-level register access dialog

A hex register ID (00 to 3F) is set in the REG ID field. The READ button initiates the read and displays the result in the REG VALUE area. The REG VALUE may be changed by the user. The WRITE button writes the current REG VALUE to the register selected by REG ID and OFFSET. The FINISHED button closes the dialog.

- Note:**
- (a) Not all registers are present, and some are write-only.
  - (b) Writing incorrect values to certain registers can upset operation completely. The only recovery from this is to reset the unit by exiting the *DecaRanging* application and removing (and restoring) power, and restarting the *DecaRanging* application.

### 3.10 Debug – Log Channel Responses

This log operation opens an automatically named text file and then information about transmitted and received data frames (including the channel impulses data) is dumped into the file. This has proved a useful aid to debugging. The log file format is described in the APPENDIX 1 – Channel Response Log.

When Logging is enabled a **STOP LOGGING** button appears on right hand side of the main control panel, defined in section 3.2.2 above. This can be used to discontinue logging and close the log file.

### 3.11 Debug – Log SPI Activity

This log operation opens an automatically named text file and then records all SPI traffic in the file. This may be useful to debugging or understand the SPI accesses used to drive the IC.

When Logging is enabled a **STOP LOGGING** button appears on right hand side of the main control panel, defined in section 3.2.2 above. This can be used to discontinue logging and close the log file.

**NOTE:** Only one logging activity is allowed, so starting an SPI log will close the channel responses log and vice versa.

### 3.12 Debug – Soft Reset (and Restart)

In the case of an issue where the software **Restart** button does not seem to resolve it, then this *Soft Reset (and Restart)* menu option might be successful in resolving the issue. This resets the hardware using a software (SPI) accessible register and then restarts the DecaRanging software. If this fails to resolve the issue after two attempts, then to recover close the DecaRanging application and power off the EVB1000 boards a few seconds before restarting again.

### 3.13 Debug – Continuous Frame Mode

The continuous frame (transmit power spectrum test) mode is used in TX power spectrum measurements. This test mode is provided to help support regulatory approvals spectral testing. Please consult with Decawave applications support team for details of regulatory approvals considerations. To calibrate the transmit power the user needs to configure the channel parameters through the Channel Configuration menu (section 3.3) and then put the device

into continuous frame mode to measure the power spectrum. DW1000 user manual describes the DW1000 calibration options in more detail.

### 3.14 Debug – Continuous Wave Mode

The continuous wave (CW test) mode is used in XTAL trim and calibration measurements. This test mode is provided to help support the calibration testing. Please consult with Decawave applications support team for details of DW1000 calibration. To calibrate the crystal oscillator’s operating frequency the user needs to configure the channel parameters through the Channel Configuration menu (section 3.3), and any other register values through the 3.9 Debug – Register Access configuration and then put the device into continuous wave mode to measure the centre frequency. DW1000 user manual describes the DW1000 calibration options in more detail.

### 3.15 Keyboard shortcuts

The various menu selections may also be enabled via the following keyboard short-cuts:

KEY	ACTION
R	Open Low-Level Register Access Dialog
A	Toggle Channel Response View Panel On/Off
C	Open Channel Configuration Dialog
P	Toggle Pause (Resume) On/Off
L	Toggle large range display View Panel On/Off
<ctrl-L>	Toggle debug log of channel responses On/Off

### 3.16 Troubleshooting

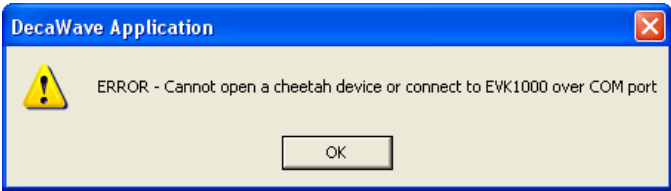
Error messages and recommended actions	
<p>(a) Connection to the board</p> 	<p>Check USB cable is connected to the EVB1000 or if Cheetah if this being used, check USB cable is connected to the cheetah and that the cheetah.dll is in the same directory as DecaRanging.exe</p> <p>Install drivers as described in section 2 above.</p>

(b) Connection to the DW1000 evaluation unit.



Check the evaluation unit is powered up and that the cheetah is correctly connected to the evaluation unit.

Refer to the separate evaluation unit user guide for details of how to set up the units and connect power and cheetah, etc.

(c) For other issues try a restart as defined in section 3.2.2.2, if that fails try a this *Soft Reset (and Restart)* see section 3.12, and if that fails after two attempts then exit the DecaRanging application and power off the evaluation unit board(s) for a few seconds before restarting again.

(d) If you are getting poor performance please check that you have both ends configured for the same channel and preamble code, preamble length etc. Also please make sure that the antennas are not loose.

(e) If the application does not start up properly this may be because of a conflict on the virtual COM port. To resolve this, go into Windows Device Manager. If the EVB is connected the "Ports (COM and LPT)" options should be visible. Inside this, the "STMicroelectronics Virtual COM Port (COMX)" should be seen (where X is the port number). If there are other devices with lower COM port numbers than the "STMicroelectronics Virtual COM Port (COMX)", please select "STMicroelectronics Virtual COM Port (COMX)", and right click into Properties, go to Port Settings tab and click Advanced. Here a different port number can be selected to be associated with this port. Set the "STMicroelectronics Virtual COM Port (COMX)" to a lower COM port number than any other connected devices. The port number must be in the range 3 to 49.



## 4 APPENDIX 1 – Channel Response Log

When the logging of the channel responses is enabled, the application will create a log file in which:

- a. TX and RX timestamps of each sent/received frame are recorded
- b. The accumulator/CIR samples of each received frame

The log file can be found in the same folder from which the executable is run and the name is of the format:

yyyymmdd\_hhmmss\_DecaWaveAllAccum.log

The figures and tables below show how to interpret the data in the log files.

### 4.1 Log File Header

Log file header is shown in Figure 20 below.

```
File:20160125-155917_DecaWaveAllAccum.log, created by DecaRanging MP Version 3.06 (build:Oct 14 2015, 11:55:02)
Mode: 0, Chan 2, Code 9, PRF 64, Plength 1024, DataRate 1, PAC 2, ic:1000099d, ucode:xxxx, antdl:8078
```

**Figure 20 - Log file header for Listener in default configuration**

Line 1 prints the file name, application name and version, and line 2 contains the mode of operation as defined in the table below.

**Table 3 - Log file header fields**

Item	Description and Notes
Mode	0 = Listener 1 = Tag (TWR tag, when ranging to an anchor) 2 = Anchor 3 = Tag TDOA (before it pairs to the anchor, i.e. when sending blinks)
Chan	This is the configured channel
Code	This is the configured preamble
PRF	This is the configured PRF 16 or 64 MHz
Plength	This is the configured preamble length
DataRate	This is the configured data rate

Item	Description and Notes
PAC	This is the configured PAC (0, 1, 2, 3 which correspond to 8, 16, 32 or 64 symbols)
ic	This is the 32-bit DW1000 part ID, see <code>dwt_getpartid</code> API function description
ucode	Reserved
antdl	Antenna delay value, as programmed in OTP or set by the application

## 4.2 TX Timestamps

The TX timestamp of each transmission is logged as shown in Figure 21. Only the adjusted timestamp is logged (i.e. raw + TX antenna delay (half of the *antdl* value)). The adjusted time stamp is a 40-bit hex number (DW1000 system time) logged as “TX Frame Timestamp Raw” and “Adding Antenna Delay” and is also converted to second format and logged as “Tx time”.

```
TX Frame TimeStamp Raw = 27 10EF903C
Adding Antenna Delay = 0027 10EF903C
00 Tx time = 2.625886731708233e+000
```

Figure 21 - TX timestamps

## 4.3 RX Timestamps

The RX timestamp of each valid frame reception is logged as shown in Figure 22. The “Rx time” is the adjusted RX timestamp (time calculated by the microcode engine in the DW1000), the “Rx time (un)” is the raw timestamp (at SFD detection). Both 40-bit hex number and its floating point seconds conversion are given.

```
C5 D2 Rx time = 4.191123923105093e+000 3E5A49D335
C5 D2 Rx time(un) = 4.191124158653846e+000 3E5A4A0E00
```

Figure 22 - RX timestamps

## 4.4 RX Data

The received frame data is also logged for each received frame, the frame payload starts with “RX DATA:” followed by the received number of bytes (as read by the `dwt_readrxdata` function in the RX callback).

## 4.5 Channel Impulse Response (CIR) Data

The accumulator contains complex values, a 16-bit real integer and a 16-bit imaginary integer, for each tap of the accumulator, each of which represents a 1 ns sample interval (or more precisely half a period of the 499.2 MHz fundamental frequency). The span of the accumulator is one symbol time. This is 992 samples for the nominal 16 MHz mean PRF, or, 1016 samples for the nominal 64 MHz mean PRF, “Accum Len” specifies how many samples follow.

```
RX OK WInd(0735), HLP(0749.0625), PSC(1023), SLP(0000.0000), RC(003E 5A49D335), DCR(0), DCI(0), NTH(03C8), T(7CB9), RSL(-084.8029), FSL(-103.1762), RSMPL(3C)
Accum Len 992
392, 18
380, 85
198, 124
132, 90
154, 92
231, 92
243, 64
...
73, 74
198, 131
89, 167
34, 183
150, 155
232, 44
```

Figure 23 - CIR data for good reception

```
RX Ex WInd(0735), PSC(1002), CE(0000), RSE(0002), HE(0012), STO(0000), FFE(0000), T(7CBA), RSL(-083.8314), FSL(-093.9841), RSMPL(00)
Accum Len 992
132, 80
-27, 128
-85, 49
-1, 7
74, 85
142, 108
```

Figure 24 - CIR log for error frame

The accumulated CIR data is logged as shown in Figure 23 and Figure 24, there are two basic types. Each CIR log of the good frame reception starts with “RX OK” and then a number of diagnostic parameters (as described in table below) followed by the real and imaginary components of the accumulator complex samples. When an error is received the CIR log will start with “RX Ex” as is shown in Figure 24.

Table 4 - CIR header data field descriptions

Item	Description and Notes
WInd	N/A
HLP	This is the index in the accumulator at which the leading edge is detected (the FP_INDEX value reported in RX_TIME register)
PSC	This is the number of accumulated symbols (RXPACC value reported in RX_FINFO register)
SLP	N/A
RC	This is the receive timestamp – same as “Rx time” see 4.3

Item	Description and Notes
DCR, DCI	N/A
NTH	Noise threshold (LDE_THRESH value reported in LDE_IF register)
T	Temperature and voltage read with dwt_readtempvbat API function at time of reception
RSL, FSL	<i>RX Level and First Path Power Level</i> as described in DW1000 User Manual (dBm)
RSMPPL	RSMPDEL as reported in RX_TTCKO register
CE	Number of CRC errors (same as EVC_FCE in register DIG_DIAG)
RSE	Number of Reed Solomon errors (same as EVC_RSE in register DIG_DIAG)
HE	Number of PHY header errors (same as EVC_PHE in register DIG_DIAG)
STO	Number of SFD timeouts (same as EVC_STO in register DIG_DIAG)
FFE	Number of frame filter rejections (same as EVC_FFR in register DIG_DIAG)

## 4.6 ToF Data

Time of flight (ToF) data is also logged, see Figure 25 below.

```
Anchor ToF: 9.164 ns Dist: 2.746600 m DistRaw: 2.626600 m DistScal: 2.626600 m Bias: -0.120 m ClockOffset: 2.411 ppm
```

**Figure 25 - ToF and clock offset data**

Table 5 below describes individual fields.

**Table 5 - TOF data fields descriptions**

Item	Description and Notes
ToF	Time of flight in nano seconds
Dist	Range calculated from the ToF value and corrected for the range bias (as per relevant table in deca_range_tables.c) in meters

Item	Description and Notes
DistRaw	Raw range (not correct for range bias) in meters
DistScal	Scaled range before applying the correction for smart TX power use case
Bias	Range bias correction applied
ClockOffset	Calculated clock offset between the tag and anchor clocks, in ppm.

## APPENDIX 2 – BIBLIOGRAPHY:

1	Decawave – DW1000 Datasheet
2	Decawave – DW1000 User Manual
3	Decawave – EVK1000 User Manual
4	IEEE 802.15.4-2011 or “IEEE Std 802.15.4™-2011” (Revision of IEEE Std 802.15.4-2006). IEEE Standard for Local and metropolitan area networks— Part 15.4: Low-Rate Wireless Personal Area Networks (LR-WPANs). IEEE Computer Society Sponsored by the LAN/MAN Standards Committee. Available from <a href="http://standards.ieee.org/">http://standards.ieee.org/</a>

## 5 DOCUMENT HISTORY

Table 6: Document History

Revision	Date	Description
2.7	March 31 <sup>st</sup> , 2015	Previous release
2.8	January 10 <sup>th</sup> , 2016	Scheduled update

## 6 MAJOR CHANGES

### v2.8

Page	Change Description
33	Added Appendix 1 – to describe the log format

## 7 ABOUT DECAWAVE

Decawave is a pioneering fabless semiconductor company whose flagship product, the DW1000, is a complete, single chip CMOS Ultra-Wideband IC based on the IEEE 802.15.4 standard UWB PHY. This device is the first in a family of parts.

The resulting silicon has a wide range of standards-based applications for both Real Time Location Systems (RTLS) and Ultra Low Power Wireless Transceivers in areas as diverse as manufacturing, healthcare, lighting, security, transport, and inventory and supply-chain management.

Further Information:

For further information on this or any other Decawave product contact a sales representative as follows: -

Decawave Ltd,  
Adelaide Chambers,  
Peter Street,  
Dublin 8,  
Ireland.

<mailto:sales@Decawave.com>

<http://www.Decawave.com/>